

- > Port size: 1/8" ... 1/2" (ISO G/NPT)
- > High flow rate at small size
- > Proven sealing system, maintenance-free
- > Different manual override options available
- > Low power consumption
- > Manifold system for easy assembly
- > Different pressure ranges possible

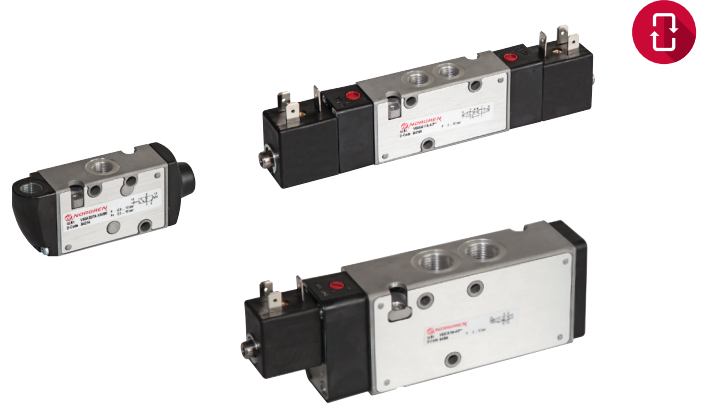

Technical features

Medium:

Compressed air, filtered lubricated or non lubricated

Operation:

Electromagnetically or pneumatically controlled

Operating pressure:

-0,9 ... 10 bar (-13 ... 145 psi)

Details see following pages

Flow:

500 ... 4500 l/min

Flow direction:

Internal pilot supply: fixed

External pilot supply: optional

Port size:

G1/8, G1/4, G3/8 or G1/2

For valves with NPT ports see option selector

Mounting position:

Optional, spring return valves, preferably horizontal

Ambient/Media temperature:

-10 ... +50°C (+14 ... +122°F)

Air supply must be dry enough to avoid ice formation at temperatures below +2°C (+35°F).

Materials:

Housing:

V60 ... V62 - Die-cast aluminium alloy

V63 - Aluminium bar stock

Base plate: Aluminium

Static and dynamic seals:

NBR and FPM

Plastic parts: PA, PBT with GF

Electrical details for solenoid operators

Voltage tolerance	± 10%	
Rating	100% continuous duty	
Inlet orifice	0,8 mm	
Electrical connection (corresponding to chosen coil)	EN 175301-803 - Form B, 22 mm	
	Industrial Standard, 22 mm	
Solenoid	4 x 90° rotatable	
Manual override	Without	# = 1
	Push and turn to lock	# = 2
	Push only (not lockable)	# = 3
Protection class	IP 65 (with sealed plug)	

3/2 directional control valves, solenoid actuated

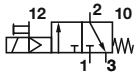
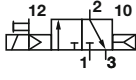
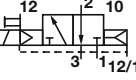
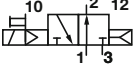
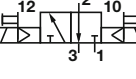
Symbol	Port size	Function	Actuation	Pilot supply	Flow (l/min)	Operating pressure (bar)	Pilot pressure (bar)	Weight (kg)	Drawing No.	Model *1)
	G1/8	NC	Solenoid/spring	Internal	750	2 ... 10	–	0,22	1	V60A417A-A#*
	G1/4	NC	Solenoid/spring	Internal	1300	2 ... 10	–	0,29	1	V61B417A-A#*
	G3/8	NC	Solenoid/spring	Internal	2600	2 ... 10	–	0,52	1	V62C417A-A#*
	G1/2	NC	Solenoid/spring	Internal	4500	2 ... 10	–	0,78	2	V63D417A-A#*
	G1/8	NC	Solenoid/air spring	Internal	750	2 ... 10	–	0,22	3	V60A413A-A#*
	G1/4	NC	Solenoid/air spring	Internal	1300	2 ... 10	–	0,29	3	V61B413A-A#*
	G3/8	NC	Solenoid/air spring	Internal	2600	2 ... 10	–	0,52	3	V62C413A-A#*
	G1/2	NC	Solenoid/air spring	Internal	4500	3 ... 10	–	0,78	4	V63D413A-A#*
	G1/8	NC	Solenoid/air spring	External	750	-0,9 ... 10	3 ... 10	0,22	3	V60A423A-A#*
	G1/4	NC	Solenoid/air spring	External	1300	-0,9 ... 10	3 ... 10	0,29	3	V61B423A-A#*
	G3/8	NC	Solenoid/air spring	External	2600	-0,9 ... 10	3 ... 10	0,52	3	V62C423A-A#*
	G1/2	NC	Solenoid/air spring	External	4500	-0,9 ... 10	3 ... 10	0,78	4	V63D423A-A#*
	G1/8	NO	Solenoid/air spring	Internal	750	2 ... 10	–	0,22	5	V60A313A-A#*
	G1/4	NO	Solenoid/air spring	Internal	1300	2 ... 10	–	0,29	5	V61B313A-A#*
	G3/8	NO	Solenoid/air spring	Internal	2600	2 ... 10	–	0,52	5	V62C313A-A#*
	G1/2	NO	Solenoid/air spring	Internal	4500	3 ... 10	–	0,78	6	V63D313A-A#*
	G1/8	NC	Solenoid/Solenoid	Internal	750	1,5 ... 10	–	0,30	7	V60A411A-A#*
	G1/4	NC	Solenoid/Solenoid	Internal	1300	1,5 ... 10	–	0,38	7	V61B411A-A#*
	G3/8	NC	Solenoid/Solenoid	Internal	2600	1,5 ... 10	–	0,61	7	V62C411A-A#*
	G1/2	NC	Solenoid/Solenoid	Internal	4500	2 ... 10	–	0,87	8	V63D411A-A#*

2 x 3/2 directional control valves, solenoid actuated

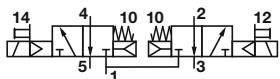
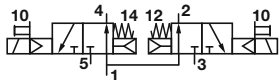
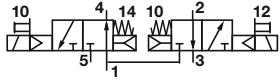
Symbol	Port size	Function	Actuation	Pilot supply	Flow (l/min)	Operating pressure (bar)	Weight (kg)	Drawing No.	Model *1)
	G1/8	NC/NC	Solenoid/Solenoid	Internal	500	2 ... 10	0,34	13	V60AA11A-A#*
	G1/4	NC/NC	Solenoid/Solenoid	Internal	950	2 ... 10	0,43	13	V61BA11A-A#*
	G3/8	NC/NC	Solenoid/Solenoid	Internal	1900	2 ... 10	0,73	13	V62CA11A-A#*
	G1/8	NO/NO	Solenoid/Solenoid	Internal	500	2 ... 10	0,34	13	V60AB11A-A#*
	G1/4	NO/NO	Solenoid/Solenoid	Internal	950	2 ... 10	0,43	13	V61BB11A-A#*
	G3/8	NO/NO	Solenoid/Solenoid	Internal	1900	2 ... 10	0,73	13	V62CB11A-A#*
	G1/8	NO/NC	Solenoid/Solenoid	Internal	500	2 ... 10	0,34	13	V60AC11A-A#*
	G1/4	NO/NC	Solenoid/Solenoid	Internal	950	2 ... 10	0,43	13	V61BC11A-A#*
	G3/8	NO/NC	Solenoid/Solenoid	Internal	1900	2 ... 10	0,73	13	V62CC11A-A#*

Insert code for manual override: 1 = without; 2 = push and turn, 3 = push only
*1) Insert voltage code from table below or 000 for version without solenoid

NC Normally closed
NO = Normally open
NC/NC = Both valves normally closed (port P)
NO/NO = Both valves normally open (port P)
NO/NC = 1 valve normally open, 1 valve normally closed (port P)

Voltage codes and spare coils

22 mm coil for connector interface acc. to industrial standard				
	Voltage	Power Inrush/Hold	Model	Code
	12 V d.c.	2 W	QM/48/12J/21	12J
	24 V d.c.	2 W	QM/48/13J/21	13J
	24 V 50/60 Hz	4/2,5 VA	QM/48/14J/21	14J
	110/120 V 50/60 Hz	4/2,5 VA	QM/48/18J/21	18J
	220/240 V 50/60 Hz	6/5,0 VA	QM/48/19J/21	19J

22 mm coil for connector interface acc. EN 175 301-803, form B				
	Voltage	Power Inrush/Hold	Model	Code
	12 V d.c.	2 W	V10626-A12L	12L
	24 V d.c.	2 W	V10626-A13L	13L
	24 V 50/60 Hz	4/2,5 VA	V10626-A14L	14L
	110/120 V 50/60 Hz	4/2,5 VA	V10626-A18L	18L
	220/240 V 50/60 Hz	6/5,0 VA	V10626-A19L	19L

Other voltage on request.

Connector plugs - ordered separately

Industrial standard 22 mm 2-pole + PE	22 mm, EN 175301-803 (DIN 43650 B) Form B 2-pole + PE
	
0657868 12...250 V a.c./d.c.	0680003 12...250 V a.c./d.c.
0680000 15...30 V DC; LED, surge suppression	0664811 15...30 V DC; LED, surge suppression
0680001 150...250 V a.c.; glim lamp	0664812 150...250 V a.c.; glim lamp

Note: Light emitting gaskets can not be used

5/2 directional control valves, solenoid actuated

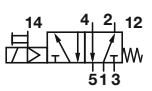
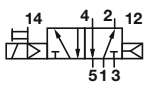
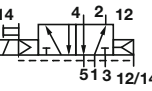
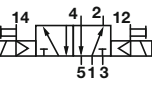
Symbol	Port size	Actuation	Pilot supply	Flow (l/min)	Operating pressure (bar)	Pilot pressure (bar)	Weight (kg)	Drawing No.	Model *1)
	G1/8	Solenoid/spring	Internal	750	3 ... 10	–	0,22	9	V60A517A-A#*
	G1/4	Solenoid/spring	Internal	1300	3 ... 10	–	0,29	9	V61B517A-A#*
	G3/8	Solenoid/spring	Internal	2600	3 ... 10	–	0,52	9	V62C517A-A#*
	G1/2	Solenoid/spring	Internal	4500	3 ... 10	–	0,96	10	V63D517A-A#*
	G1/8	Solenoid/air spring	Internal	750	2 ... 10	–	0,24	11	V60A513A-A#*
	G1/4	Solenoid/air spring	Internal	1300	2 ... 10	–	0,33	11	V61B513A-A#*
	G3/8	Solenoid/air spring	Internal	2600	2 ... 10	–	0,62	11	V62C513A-A#*
	G1/2	Solenoid/air spring	Internal	4500	3 ... 10	–	0,96	12	V63D513A-A#*
	G1/8	Solenoid/air spring	External	750	-0,9 ... 10	3 ... 10	0,24	11	V60A523A-A#*
	G1/4	Solenoid/air spring	External	1300	-0,9 ... 10	3 ... 10	0,33	11	V61B523A-A#*
	G3/8	Solenoid/air spring	External	2600	-0,9 ... 10	3 ... 10	0,62	11	V62C523A-A#*
	G1/2	Solenoid/air spring	External	4500	-0,9 ... 10	3 ... 10	0,96	12	V63D523A-A#*
	G1/8	Solenoid/Solenoid	Internal	750	1,5 ... 10	–	0,33	13	V60A511A-A#*
	G1/4	Solenoid/Solenoid	Internal	1300	1,5 ... 10	–	0,42	13	V61B511A-A#*
	G3/8	Solenoid/Solenoid	Internal	2600	1,5 ... 10	–	0,72	13	V62C511A-A#*
	G1/2	Solenoid/Solenoid	Internal	4500	2 ... 10	–	0,98	14	V63D511A-A#*

5/3 directional control valves, solenoid actuated

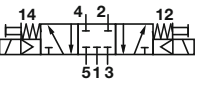
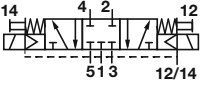
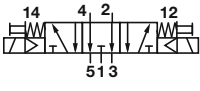
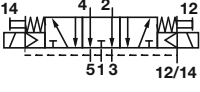
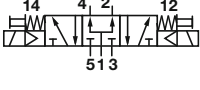
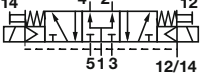
Symbol	Port size	Function	Actuation	Pilot supply	Flow (l/min)	Operating pressure (bar)	Pilot pressure (bar)	Weight (kg)	Drawing No.	Model *1)
	G1/8	APB	Solenoid/Solenoid	Internal	500	3 ... 10	–	0,35	15	V60A611A-A#*
	G1/4	APB	Solenoid/Solenoid	Internal	950	3 ... 10	–	0,47	15	V61B611A-A#*
	G3/8	APB	Solenoid/Solenoid	Internal	1900	3 ... 10	–	0,81	15	V62C611A-A#*
	G1/8	APB	Solenoid/Solenoid	External	500	-0,9 ... 10	3 ... 10	0,35	15	V60A622A-A#*
	G1/4	APB	Solenoid/Solenoid	External	950	-0,9 ... 10	3 ... 10	0,47	15	V61B622A-A#*
	G3/8	APB	Solenoid/Solenoid	External	1900	-0,9 ... 10	3 ... 10	0,81	15	V62C622A-A#*
	G1/8	COE	Solenoid/Solenoid	Internal	500	3 ... 10	–	0,35	15	V60A711A-A#*
	G1/4	COE	Solenoid/Solenoid	Internal	950	3 ... 10	–	0,47	15	V61B711A-A#*
	G3/8	COE	Solenoid/Solenoid	Internal	1900	3 ... 10	–	0,81	15	V62C711A-A#*
	G1/8	COE	Solenoid/Solenoid	External	500	-0,9 ... 10	3 ... 10	0,35	15	V60A722A-A#*
	G1/4	COE	Solenoid/Solenoid	External	950	-0,9 ... 10	3 ... 10	0,47	15	V61B722A-A#*
	G3/8	COE	Solenoid/Solenoid	External	1900	-0,9 ... 10	3 ... 10	0,81	15	V62C722A-A#*
	G1/8	COP	Solenoid/Solenoid	Internal	500	3 ... 10	–	0,35	15	V60A811A-A#*
	G1/4	COP	Solenoid/Solenoid	Internal	950	3 ... 10	–	0,47	15	V61B811A-A#*
	G3/8	COP	Solenoid/Solenoid	Internal	1900	3 ... 10	–	0,81	15	V62C811A-A#*
	G1/8	COP	Solenoid/Solenoid	External	500	-0,9 ... 10	3 ... 10	0,35	15	V60A822A-A#*
	G1/4	COP	Solenoid/Solenoid	External	950	-0,9 ... 10	3 ... 10	0,47	15	V61B822A-A#*
	G3/8	COP	Solenoid/Solenoid	External	1900	-0,9 ... 10	3 ... 10	0,81	15	V62C822A-A#*

Insert code for manual override: 1 = without; 2 = push and turn, 3 = push only

*1) Insert voltage code from table on page before or 000 for version without solenoid

APB = All ports blocked

COE = Centre open exhaust

COP = Centre open pressure

3/2 directional control valves, pilot actuated

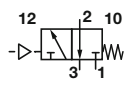
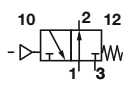
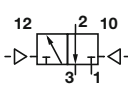
Symbol	Port size	Function	Actuation	Flow (l/min)	Operating pressure (bar)	Pilot pressure external (bar)	Weight (kg)	Drawing No.	Model
	G1/8	NC	Air/Spring	750	-0,9 ... 10	2,5 ... 10	0,13	31	V60A4D7A-XA090
	G1/4	NC	Air/Spring	1300	-0,9 ... 10	2,5 ... 10	0,21	31	V61B4D7A-XA090
	G3/8	NC	Air/Spring	2600	-0,9 ... 10	2,5 ... 10	0,43	33	V62C4D7A-XA090
	G1/2	NC	Air/Spring	4500	-0,9 ... 16	3 ... 16	0,75	35	V63D4D7A-XA090
	G1/8	NO	Air/Spring	750	-0,9 ... 10	2,5 ... 10	0,13	32	V60A3D7A-XA090
	G1/4	NO	Air/Spring	1300	-0,9 ... 10	2,5 ... 10	0,21	32	V61B3D7A-XA090
	G3/8	NO	Air/Spring	2600	-0,9 ... 10	2,5 ... 10	0,43	34	V62C3D7A-XA090
	G1/2	NO	Air/Spring	4500	-0,9 ... 16	3 ... 16	0,75	36	V63D3D7A-XA090
	G1/8	NC	Air/Air	750	-0,9 ... 10	1,5 ... 10	0,13	37	V60A4DDA-XA020
	G1/4	NC	Air/Air	1300	-0,9 ... 10	1,5 ... 10	0,21	37	V61B4DDA-XA020
	G3/8	NC	Air/Air	2600	-0,9 ... 10	1,5 ... 10	0,43	38	V62C4DDA-XA020
	G1/2	NC	Air/Air	4500	-0,9 ... 16	1,5 ... 16	0,68	39	V63D4DDA-XA020

2 x 3/2 directional control valves, pilot actuated

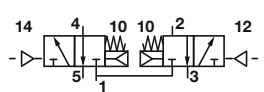
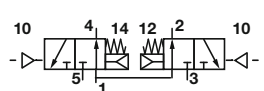
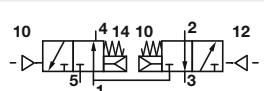
Symbol	Port size	Function	Actuation	Flow (l/min)	Operating pressure (bar)	Pilot pressure external (bar)	Weight (kg)	Drawing No.	Model
	G1/8	NC/NC	Air/Air	500	2 ... 10	2 ... 10	0,18	43	V60AADDA-XA020
	G1/4	NC/NC	Air/Air	950	2 ... 10	2 ... 10	0,28	43	V61BADDA-XA020
	G3/8	NC/NC	Air/Air	1900	2 ... 10	2 ... 10	0,60	44	V62CADDA-XA020
	G1/8	NO/NO	Air/Air	500	2 ... 10	2 ... 10	0,18	43	V60ABDDA-XA020
	G1/4	NO/NO	Air/Air	950	2 ... 10	2 ... 10	0,28	43	V61BDDDA-XA020
	G3/8	NO/NO	Air/Air	1900	2 ... 10	2 ... 10	0,60	44	V62CBDDA-XA020
	G1/8	NO/NC	Air/Air	500	2 ... 10	2 ... 10	0,18	43	V60ACDDA-XA020
	G1/4	NO/NC	Air/Air	950	2 ... 10	2 ... 10	0,28	43	V61BCDDA-XA020
	G3/8	NO/NC	Air/Air	1900	2 ... 10	2 ... 10	0,60	44	V62CCDDA-XA020

5/2 directional control valves, pilot actuated

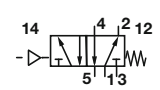
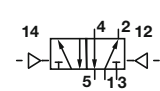
Symbol	Port size	Function	Actuation	Flow (l/min)	Operating pressure (bar)	Pilot pressure external (bar)	Weight (kg)	Drawing No.	Model
	G1/8	Air/Spring		750	-0,9 ... 10	2,5 ... 10	0,16	40	V60A5D7A-XA090
	G1/4	Air/Spring		1300	-0,9 ... 10	2,5 ... 10	0,26	40	V61B5D7A-XA090
	G3/8	Air/Spring		2600	-0,9 ... 10	2,5 ... 10	0,56	41	V62C5D7A-XA090
	G1/2	Air/Spring		4500	-0,9 ... 16	3 ... 16	0,92	42	V63D5D7A-XA090
	G1/8	Air/Air		750	-0,9 ... 10	1,5 ... 10	0,17	43	V60A5DDA-XA020
	G1/4	Air/Air		1300	-0,9 ... 10	1,5 ... 10	0,27	43	V61B5DDA-XA020
	G3/8	Air/Air		2600	-0,9 ... 10	1,5 ... 10	0,58	44	V62C5DDA-XA020
	G1/2	Air/Air		4500	-0,9 ... 16	1,5 ... 16	0,87	45	V63D5DDA-XA020

5/3 directional control valves, pilot actuated

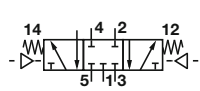
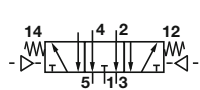
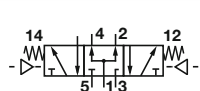
Symbol	Port size	Function	Actuation	Flow (l/min)	Operating pressure (bar)	Pilot pressure external (bar)	Weight (kg)	Drawing No.	Model
	G1/8	APB	Air/Air	500	-0,9 ... 10	3 ... 10	0,20	46	V60A6DDA-XA020
	G1/4	APB	Air/Air	950	-0,9 ... 10	3 ... 10	0,32	46	V61B6DDA-XA020
	G3/8	APB	Air/Air	1900	-0,9 ... 10	3 ... 10	0,67	47	V62C6DDA-XA020
	G1/2	APB	Air/Air	2300	-0,9 ... 10	3 ... 10	1,10	48	V63D6DDA-XA020
	G1/8	COE	Air/Air	500	-0,9 ... 10	3 ... 10	0,20	46	V60A7DDA-XA020
	G1/4	COE	Air/Air	950	-0,9 ... 10	3 ... 10	0,32	46	V61B7DDA-XA020
	G3/8	COE	Air/Air	1900	-0,9 ... 10	3 ... 10	0,67	47	V62C7DDA-XA020
	G1/2	COE	Air/Air	2300	-0,9 ... 10	3 ... 10	1,10	48	V63D7DDA-XA020
	G1/8	COP	Air/Air	500	-0,9 ... 10	3 ... 10	0,20	46	V60A8DDA-XA020
	G1/4	COP	Air/Air	950	-0,9 ... 10	3 ... 10	0,32	46	V61B8DDA-XA020
	G3/8	COP	Air/Air	1900	-0,9 ... 10	3 ... 10	0,67	47	V62C8DDA-XA020

NC = Normally closed

NO = Normally open

NC/NC = Both valves normally closed (port P)

NO/NO = Both valves normally open (port P)

NO/NC = 1 valve normally open, 1 valve normally closed (port P)

APB = All ports blocked

COE = Centre open exhaust

COP = Centre open pressure

**Option selector
(directional control valves,
solenoid actuated)**
V6***A-A*******

Valve size	Substitute
G1/8	0A
G1/4	1B
G3/8	2C
G1/2	3D
NPT-Valve size	Substitute
1/8 NPT	0P
1/4 NPT	1R
3/8 NPT	2S
1/2 NPT	3T
Function	Substitute
3/2 - NO	3
3/2 - NC	4
5/2	5
5/3 - APB	6
5/3 - COE	7
5/3 - COP	8
2 x 3/2 - NC	A
2 x 3/2 - NO	B
2 x 3/2 - NO/NC	C



Plug Interface	Substitute	
22 mm, industrial standard	J	
22 mm, to EN 175301-803 (DIN 43650), Form B	L	
Voltage	Substitute	
12 V d.c. 2 W	12	
24 V d.c. 2 W	13	
24 V a.c. (50/60 Hz) 4/2,5 VA	14	
110/120 V a.c. (50/60 Hz) 4/2,5 VA	18	
220/240 V a.c. (50/60 Hz) 6/5 VA	19	
Manual override	Substitute	
Push, locked position	2	
Push only	3	
Without	1	
Actuation/return	Pilot Supply	Substitute
Sol/Sol	Internal	11
Sol/air spring	Internal	13
Sol/spring	Internal	17
Sol/Sol	External	22
Sol/air spring	External	23
Sol/spring	External	27

**Option selector
(directional control valves,
pilot actuated)**
V6**D*A-X****0**

Port size ISO G	Substitute
G1/8	0A
G1/4	1B
G3/8	2C
G1/2	3D
Port size NPT	Substitute
1/8 NPT	0P
1/4 NPT	1R
3/8 NPT	2S
1/2 NPT	3T
Function	Substitute
3/2 - NO	3
3/2 - NC	4
5/2	5
5/3 - APB	6
5/3 - COE	7
5/3 - COP	8
2 x 3/2 - NC	A
2 x 3/2 - NO	B
2 x 3/2 - NO/NC	C

Actuation/return	Substitute
Air/Air	02
Air/Spring	09
Pilot port	Substitute
G1/8	A
1/8 NPT	P
Actuation/return	Substitute
Air/Air	D
Air/Spring	7

Manifold system for common pressure supply (V60 and V61)

	Manifold* 2 to 9 stations	10 and 12 stations	Bracket for manifold	Blanking plug for unused valve station
				
Series	Page 19	Page 19	Page 19	
V60	263962 *1)	263963 *2)	0555485	0491586
V61	263942 *1)	263943 *2)	0555484	0491587

* Supplied with bolt and sealing washers





*1) Insert station code after model numbers: 2, 3, 4, 5, 6, 7 and 8

*2) Insert station code after model numbers: 9 (for V61 only), 0 for 10 and 2 for 12



Sub-bases

	Valve stations 2	3	4	6	12
					
Series	Page 17	Page 17	Page 17	Page 17	Page 17
V60	2221002	2221003	2221004	2221006	2221012
V61	2221102	2221103	2221104	2221106	2221112
V62	2221202	2221203	2221204	2221206	2221212

Accessories for sub-bases

	Blanking plate	Blanking plug for 2 station and 3 station manifolds	Pressure shut-off for 4 station up to 12 station manifolds	Pressure shut-off for ports 3 & 5 (R & S)	DIN rail mounting kit
					
Series			Page 17	Page 17	Page 18
V60	0100561	0701208	0100567	0110236	0101796
V61	0100563	0701209	0100569	0110237	0101796
V62	0100565	0701210	0100571	0110238	0101796

Coil accessories

Diffuser for pilot exhaust	Circlip for coil fixing
	
81110800	81021600

Dimensions

Dimensions in mm
Projection/First angle

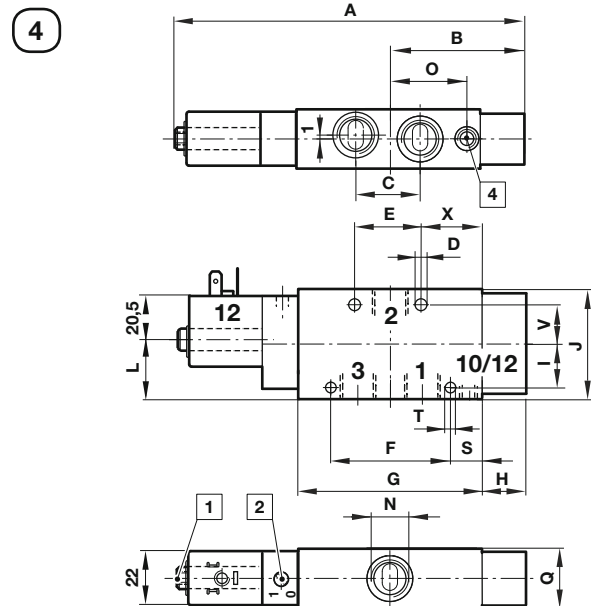
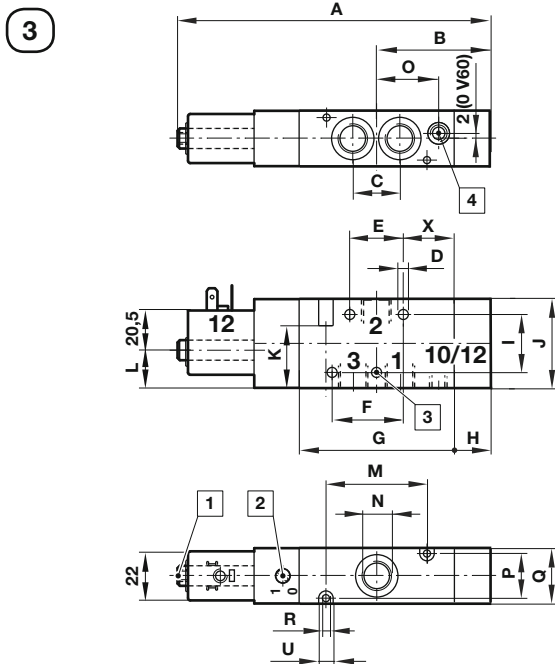
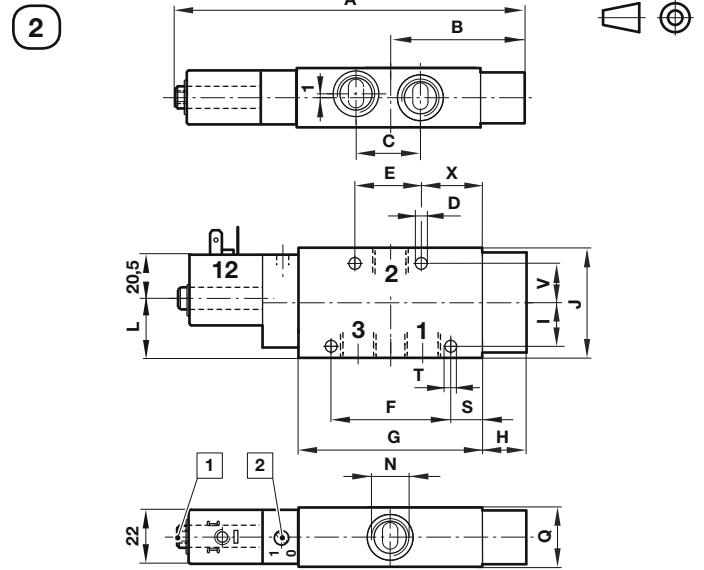
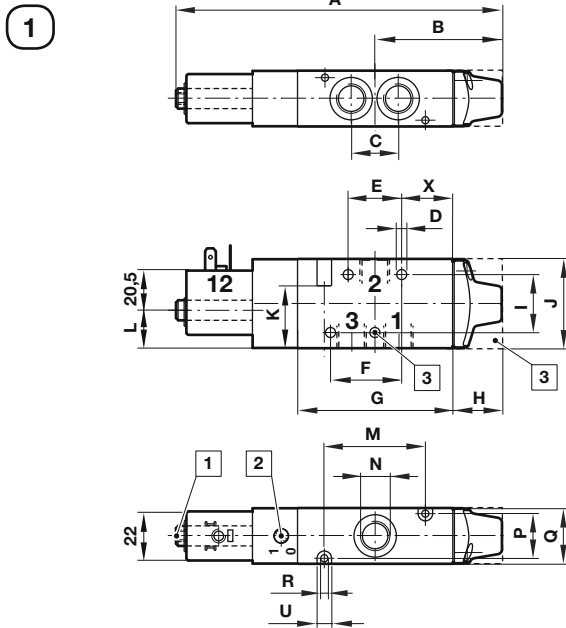

- 1 Collected pilot exhaust (M5)
- 2 Manual Override

- 3 V62: Central mounting hole (left hole is not applicable) and square end cover
- 4 External pilot port, M5 or 10-32 UNF (V60, V61 & V62), G1/8 or 1/8-27 NPT (V63)

No.	A	B	C	ØD	E	F	G	H	I	J	K	L	M	N	O	P	Q	ØR	S	ØT	ØU	V	X	Model
1	125	45	16	4,5	18	25	56	17	26	35	28	12	35	G1/8	—	17	22	3,2	—	—	6,5	—	19	V60A417A—...
1	147	57,5	21	4,5	24	32	70	22,5	26	40	28	17	46	G1/4	—	20	25	3,2	—	—	6,5	—	23	V61B417A—...
1	166,5	70	24,5	4,5	26	—	83,5	28	36	55	44	32	54	G3/8	—	28	34	4,5	—	—	8,0	23	30	V62C417A—...
2	197	87,5	38	7	46	75	108	33,5	26	65	—	38	—	G1/2	—	—	35	—	18,5	5,5	—	—	36	V63D417A—...
3	116,5	37	16	4,5	18	25	56	9	26	35	28	12	35	G1/8	—	17	22	3,2	—	—	6,5	—	19	V60A413A—...
3	132,5	43	21	4,5	24	32	70	8	26	40	28	17	46	G1/4	—	20	25	3,2	—	—	6,5	—	23	V61B413A—...
3	147	50,5	24,5	4,5	26	—	83,5	9	36	55	44	32	54	G3/8	—	28	34	4,5	—	—	8,0	—	30	V62C413A—...
3	116,5	37	16	4,5	18	25	56	9	26	35	28	12	35	G1/8	22	17	22	3,2	—	—	6,5	—	19	V60A423A—...
3	132,5	43	21	4,5	24	32	70	8	26	40	28	17	46	G1/4	29	20	25	3,2	—	—	6,5	—	23	V61B423A—...
3	147	50,5	24,5	4,5	26	—	83,5	9	36	55	44	32	54	G3/8	—	28	34	4,5	—	—	8,0	—	30	V62C423A—...
4	190	80	38	7,0	46	75	108	26	26	65	—	38	—	G1/2	—	—	35	—	18,5	5,5	—	23	36	V63D413A—...
4	190	80	38	7,0	46	75	108	26	26	65	—	38	—	G1/2	45	—	35	—	18,5	5,5	—	23	36	V63D423A—...

5

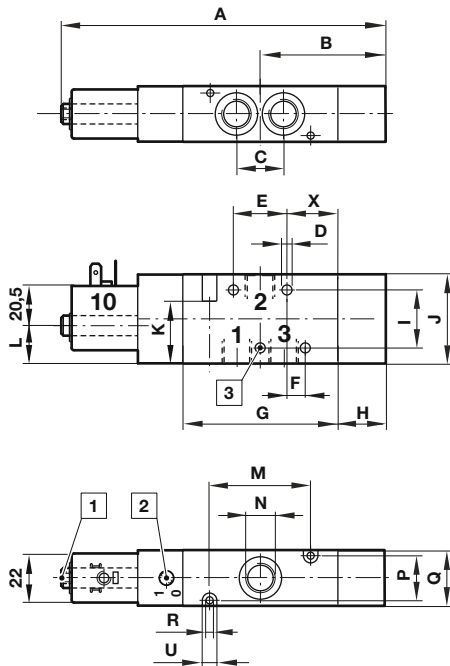

6

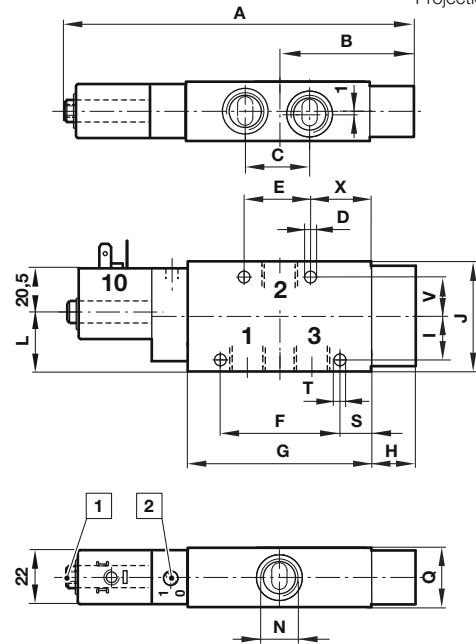

Dimensions in mm
Projection/First angle



7

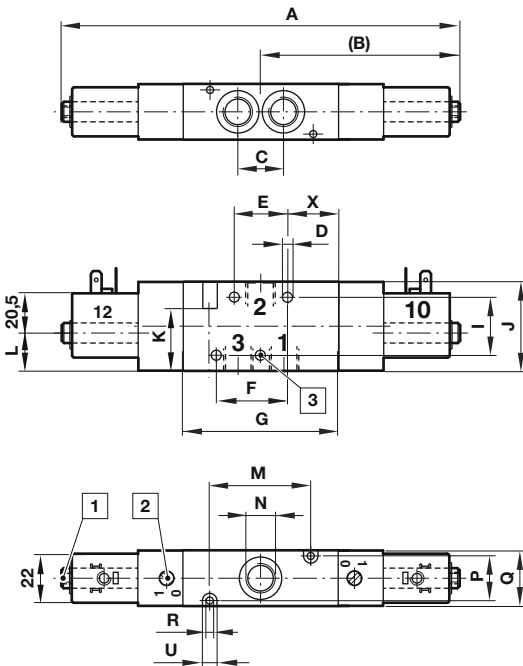

8

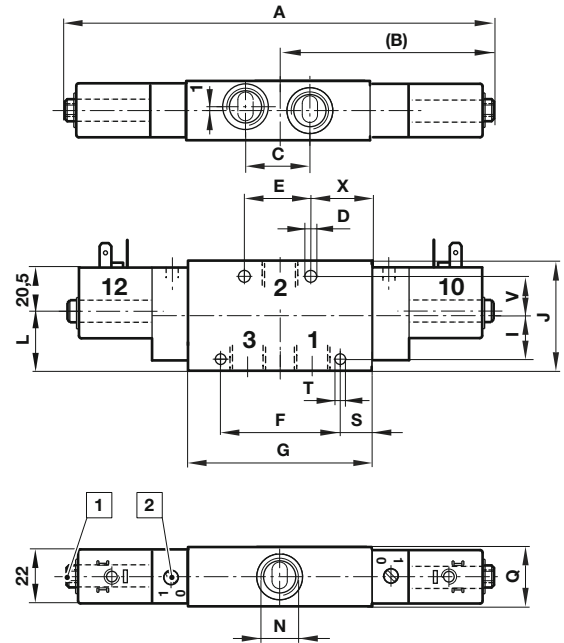

- 1 Collected pilot exhaust (M5)
- 2 Manual Override

- 3 V62: Central mounting hole (left hole is not applicable) and square end cover

No.	A	B	C	ØD	E	F	G	H	I	J	K	L	M	N	P	Q	ØR	S	ØT	ØU	V	X	Model
5	116,5	37	16	4,5	18	7	56	9	26	35	28	12	35	G1/8	17	22	3,2	—	—	6,5	—	19	V60A313A—...
5	132,5	43	21	4,5	24	8	70	8	26	40	28	17	46	G1/4	20	25	3,2	—	—	6,5	—	23	V61B313A—...
5	147	50,5	24,5	4,5	26	—	83,5	9	36	55	44	32	54	G3/8	28	34	4,5	—	—	8,0	—	28	V62C313A—...
6	190	80	38	7,0	46	75	108	26	26	65	—	38	—	G1/2	—	35	—	14,5	5,5	—	23	26	V63D313A—...
7	159,5	79,5	16	4,5	18	25	56	—	26	35	28	12	35	G1/8	17	22	3,2	—	—	6,5	—	19	V60A411A—...
7	179	89,5	21	4,5	24	32	70	—	26	40	28	17	46	G1/4	20	25	3,2	—	—	6,5	—	23	V61B411A—...
7	193,5	97	24,5	4,5	26	—	83,5	—	36	55	44	32	54	G3/8	28	34	4,5	—	—	8,0	—	30	V62C411A—...
8	219	109,5	38	7,0	46	75	108	—	26	65	—	38	—	G1/2	—	35	—	18,5	5,5	—	23	36	V63D411A—...

9

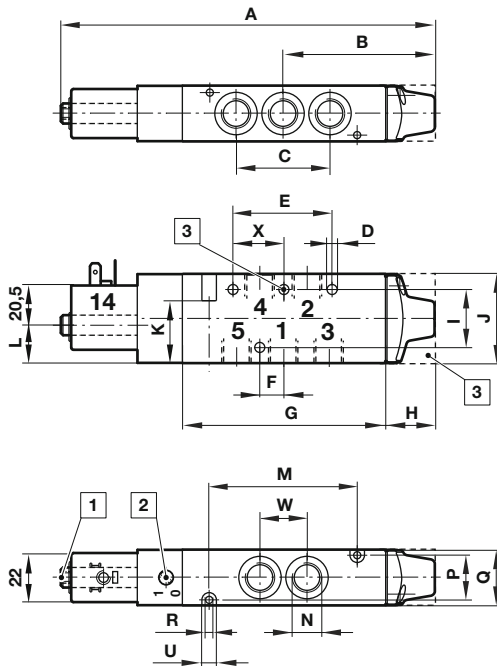

10

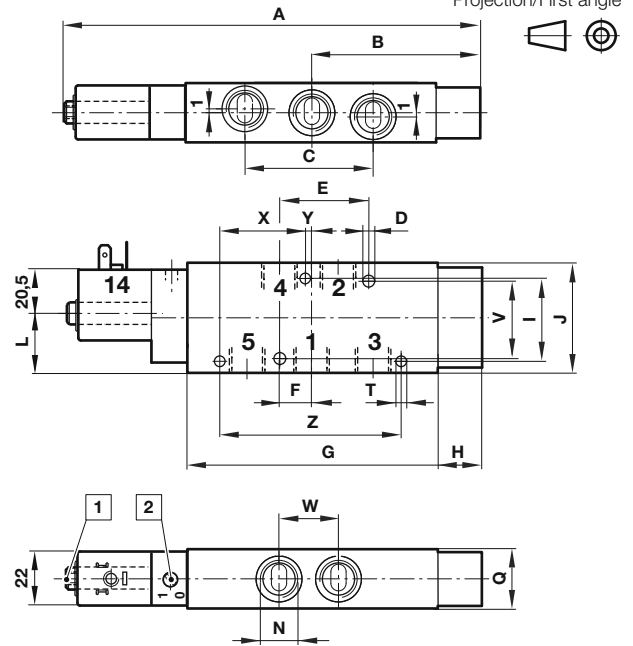

Dimensions in mm
Projection/First angle

11

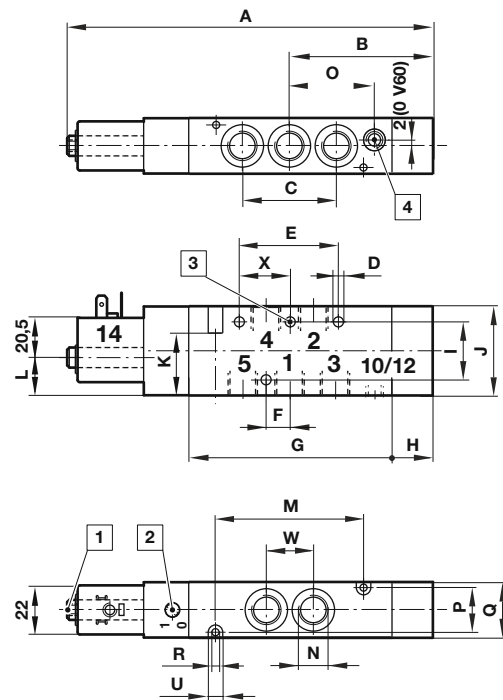

12

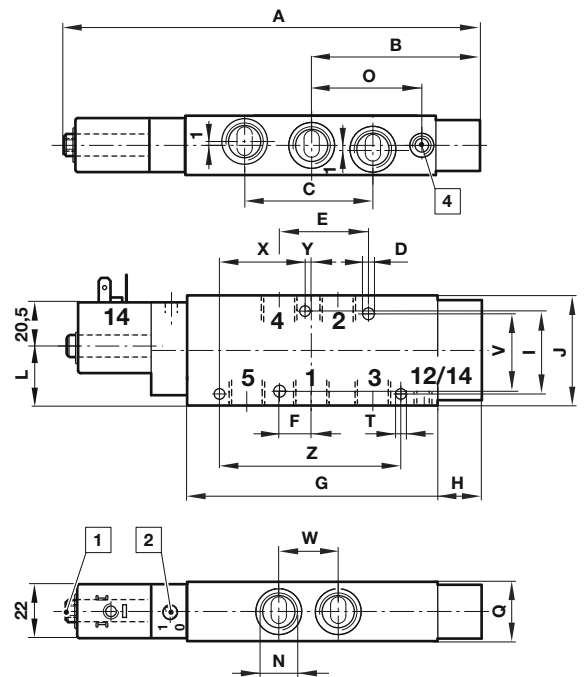

- 1 Collected pilot exhaust (M5)
- 2 Manual Override

- 3 V62: Central mounting hole (left hole is not applicable) and square end cover
- 4 External pilot port, M5 or 10-32 UNF (V60, V61 & V62), G1/8 or 1/8-27 NPT (V63)

No.	A	B	C	ØD	E	F	G	H	I	J	K	L	M	N	O	P	Q	ØR	ØT	ØU	V	W	X	Y	Z	Model
9	140	52,5	32,5	4,5	33,5	8	71	17	26	35	28	12	50	G1/8	—	17	22	3,2	—	6,5	—	16	17	—	—	V60A517A—...
9	167	67,5	42	4,5	44	10	90	22,5	26	40	28	17	66	G1/4	—	20	25	3,2	—	6,5	—	21	22	—	—	V61B517A—...
9	191	82	49	4,5	—	12	108	28	36	55	44	32	78	G3/8	—	28	34	4,5	—	8,0	—	24,5	26	—	—	V62C517A—...
10	235	106,5	76	7,0	60	19	146	33,5	52	65	—	38	—	G1/2	—	—	35	—	5,5	—	46	38	57,5	3	115	V63D517A—...
11	132	44,5	32,5	4,5	33,5	8	71	9	26	35	28	12	50	G1/8	—	17	22	3,2	—	6,5	—	16	17	—	—	V60A513A—...
11	153	53	42	4,5	44	10	90	8	26	40	28	17	66	G1/4	—	20	25	3,2	—	6,5	—	21	22	—	—	V61B513A—...
11	171,5	62,5	49	4,5	—	12	108	8,5	36	55	44	32	78	G3/8	—	28	34	4,5	—	8,0	—	24,5	26	—	—	V62C513A—...
12	228	99	76	7,0	60	19	146	26	52	65	—	38	—	G1/2	—	—	35	—	5,5	—	46	38	57,5	3	115	V63D513A—...
11	132	44,5	32,5	4,5	33,5	8	71	9	26	35	28	12	50	G1/8	29,5	17	22	3,2	—	6,5	—	16	17	—	—	V60A523A—...
11	153	53	42	4,5	44	10	90	8	26	40	28	17	66	G1/4	39	20	25	3,2	—	6,5	—	21	22	—	—	V61B523A—...
11	171,5	62,5	49	4,5	—	12	108	8,5	36	55	44	32	78	G3/8	48	28	34	4,5	—	8,0	—	24,5	26	—	—	V62C523A—...
12	228	99	76	7,0	60	19	146	26	52	65	—	38	—	G1/2	64	—	35	—	5,5	—	46	38	57,5	3	115	V63D523A—...

13

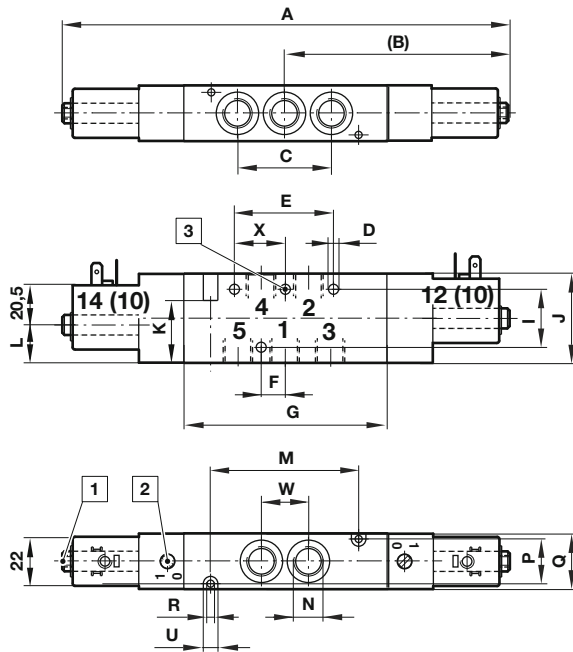

14

Dimensions in mm
Projection/First angle

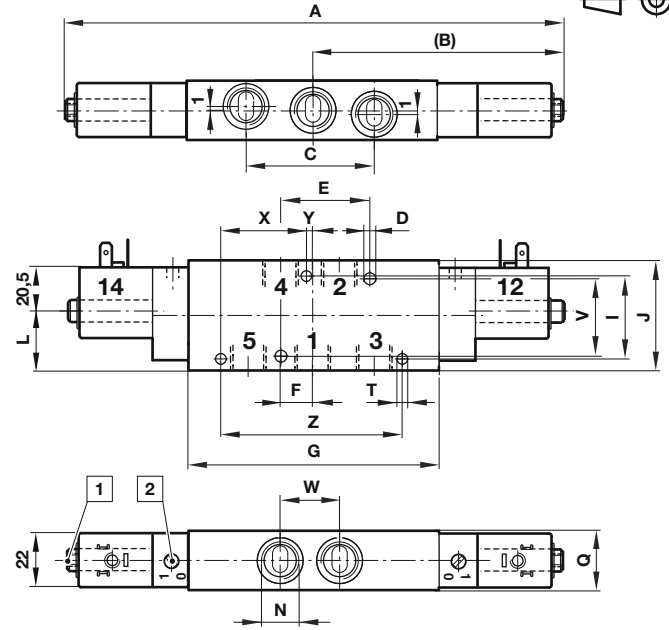

- 1 Collected pilot exhaust (M5)
- 2 Manual Override
- 3 V62: Central mounting hole (left hole is not applicable)

No.	A	B	C	ØD	E	F	G	I	J	K	L	M	N	P	Q	ØR	ØT	ØU	V	W	X	Y	Z	Model
13	174,5	87,5	32,5	4,5	33,5	8	71	26	35	28	12	50	G1/8	17	22	3,2	—	6,5	—	16	17	—	—	V60A511A—...
13	174,5	87,5	32,5	4,5	33,5	8	71	26	35	28	12	50	G1/8	17	22	3,2	—	6,5	—	16	17	—	—	V60AA11A—...
13	174,5	87,5	32,5	4,5	33,5	8	71	26	35	28	12	50	G1/8	17	22	3,2	—	6,5	—	16	17	—	—	V60AB11A—...
13	174,5	87,5	32,5	4,5	33,5	8	71	26	35	28	12	50	G1/8	17	22	3,2	—	6,5	—	16	17	—	—	V60AC11A—...
13	199	99,5	42	4,5	44	10	90	26	40	28	17	66	G1/4	20	25	3,2	—	6,5	—	21	22	—	—	V61B511A—...
13	199	99,5	42	4,5	44	10	90	26	40	28	17	66	G1/4	20	25	3,2	—	6,5	—	21	22	—	—	V61BA11A—...
13	199	99,5	42	4,5	44	10	90	26	40	28	17	66	G1/4	20	25	3,2	—	6,5	—	21	22	—	—	V61BB11A—...
13	199	99,5	42	4,5	44	10	90	26	40	28	17	66	G1/4	20	25	3,2	—	6,5	—	21	22	—	—	V61BC11A—...
13	218	109	49	4,5	—	12	108	36	55	44	32	78	G3/8	28	34	4,5	—	8,0	—	24,5	26	—	—	V62C511A—...
13	218	109	49	4,5	—	12	108	36	55	44	32	78	G3/8	28	34	4,5	—	8,0	—	24,5	26	—	—	V62CA11A—...
13	218	109	49	4,5	—	12	108	36	55	44	32	78	G3/8	28	34	4,5	—	8,0	—	24,5	26	—	—	V62CB11A—...
13	218	109	49	4,5	—	12	108	36	55	44	32	78	G3/8	28	34	4,5	—	8,0	—	24,5	26	—	—	V62CC11A—...
14	257	128,5	76	7,0	60	19	146	52	65	—	38	—	G1/2	—	35	—	5,5	—	46	38	57,5	3	115	V63D511A—...

15

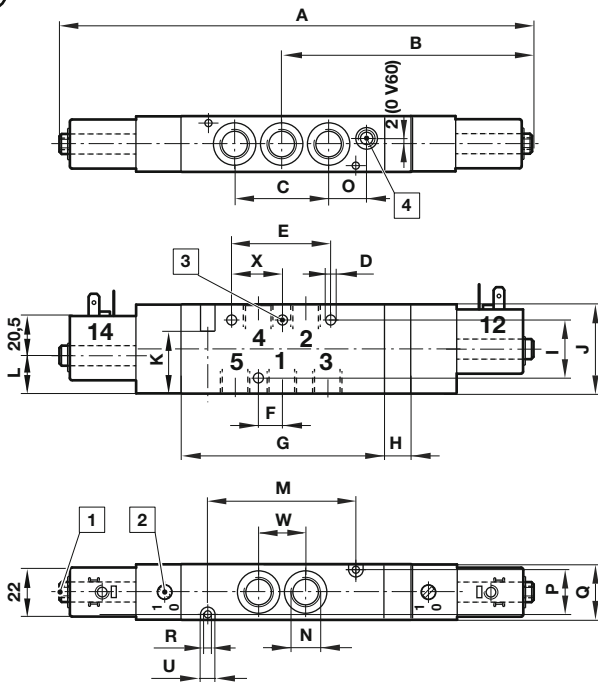
 Dimensions in mm
Projection/First angle

- 1** Collected pilot exhaust (M5)
- 2** Manual Override
- 3** V62: Central mounting hole (left hole is not applicable) and square end cover
- 4** External pilot port, M5 or 10-32 UNF (V60, V61 & V62)

No.	A	B	C	ØD	E	F	G	H	I	J	K	L	M	N	O	P	Q	ØR	ØU	W	X	Model
15	188,5	101,5	32,5	4,5	33,5	8	71	14	26	35	28	12	50	G1/8	13	17	22	3,2	6,5	16	17	V60A611A—...
15	188,5	101,5	32,5	4,5	33,5	8	71	14	26	35	28	12	50	G1/8	13	17	22	3,2	6,5	16	17	V60A622A—...
15	188,5	101,5	32,5	4,5	33,5	8	71	14	26	35	28	12	50	G1/8	13	17	22	3,2	6,5	16	17	V60A711A—...
15	188,5	101,5	32,5	4,5	33,5	8	71	14	26	35	28	12	50	G1/8	13	17	22	3,2	6,5	16	17	V60A722A—...
15	188,5	101,5	32,5	4,5	33,5	8	71	14	26	35	28	12	50	G1/8	13	17	22	3,2	6,5	16	17	V60A811A—...
15	188,5	101,5	32,5	4,5	33,5	8	71	14	26	35	28	12	50	G1/8	13	17	22	3,2	6,5	16	17	V60A822A—...
15	217	117,5	42	4,5	44	10	90	18	26	40	28	17	66	G1/4	18	20	25	3,2	6,5	21	22	V61B611A—...
15	217	117,5	42	4,5	44	10	90	18	26	40	28	17	66	G1/4	18	20	25	3,2	6,5	21	22	V61B622A—...
15	217	117,5	42	4,5	44	10	90	18	26	40	28	17	66	G1/4	18	20	25	3,2	6,5	21	22	V61B711A—...
15	217	117,5	42	4,5	44	10	90	18	26	40	28	17	66	G1/4	18	20	25	3,2	6,5	21	22	V61B722A—...
15	217	117,5	42	4,5	44	10	90	18	26	40	28	17	66	G1/4	18	20	25	3,2	6,5	21	22	V61B811A—...
15	217	117,5	42	4,5	44	10	90	18	26	40	28	17	66	G1/4	18	20	25	3,2	6,5	21	22	V61B822A—...
15	240,5	131,5	49	4,5	—	12	108	22,5	36	55	44	32	78	G3/8	23,5	28	34	4,5	8	24,5	26	V62C611A—...
15	240,5	131,5	49	4,5	—	12	108	22,5	36	55	44	32	78	G3/8	23,5	28	34	4,5	8	24,5	26	V62C622A—...
15	240,5	131,5	49	4,5	—	12	108	22,5	36	55	44	32	78	G3/8	23,5	28	34	4,5	8	24,5	26	V62C711A—...
15	240,5	131,5	49	4,5	—	12	108	22,5	36	55	44	32	78	G3/8	23,5	28	34	4,5	8	24,5	26	V62C722A—...
15	240,5	131,5	49	4,5	—	12	108	22,5	36	55	44	32	78	G3/8	23,5	28	34	4,5	8	24,5	26	V62C811A—...
15	240,5	131,5	49	4,5	—	12	108	22,5	36	55	44	32	78	G3/8	23,5	28	34	4,5	8	24,5	26	V62C811A—...

Dimensions in mm
Projection/First angle

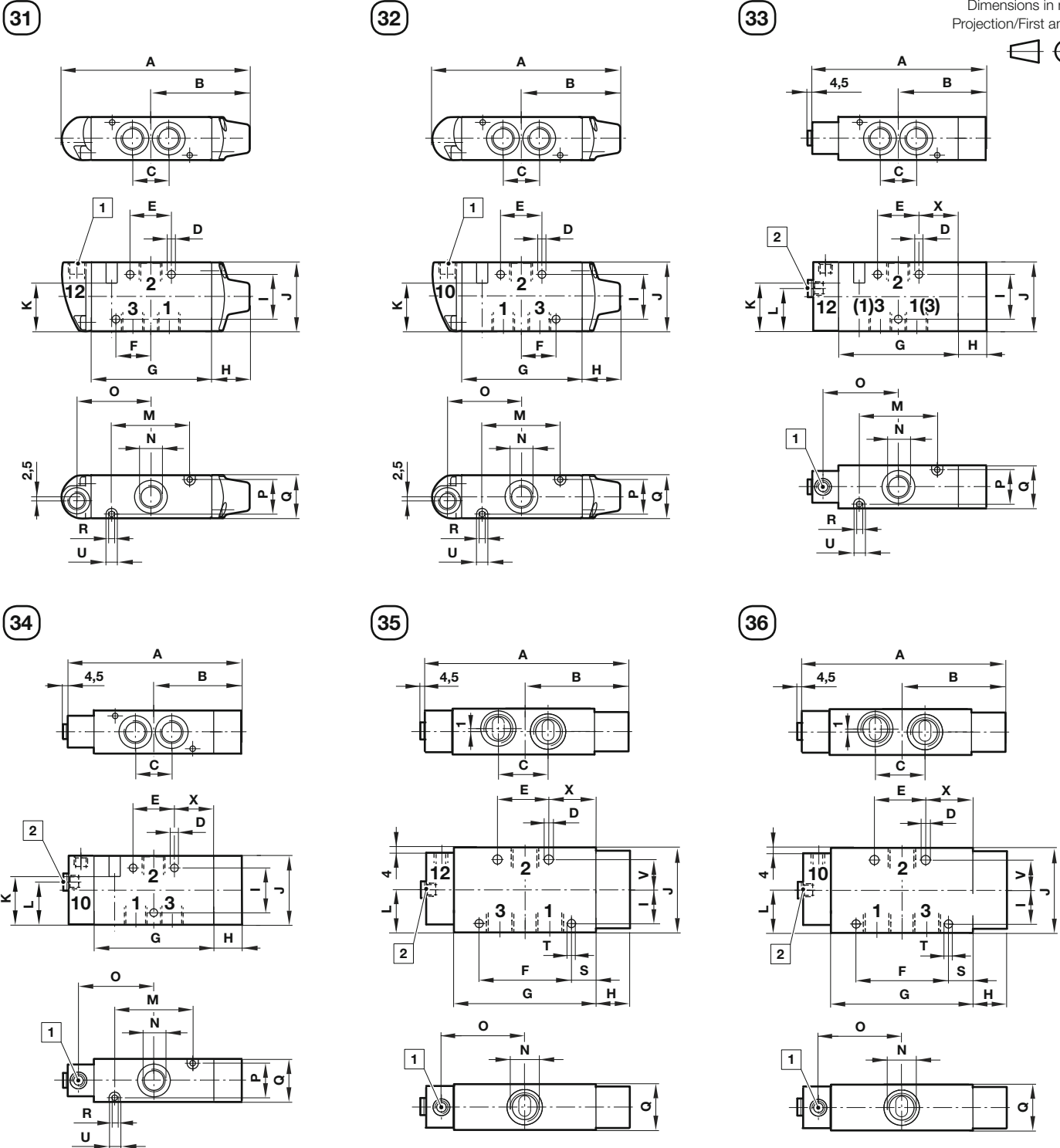

- 1 Pilot ports G1/8 or 1/8-27 NPT
- 2 Alternative pilot ports G1/8 or 1/8-27 NPT

No.	A	B	C	ØD	E	F	G	H	I	J	K	L	M	N	O	P	Q	ØR	S	ØT	ØU	V	X	Model	
31	89,5	45	16	4,5	18	16	56	17	26	35	28	—	35	G1/8	36	17	22	3,2	—	—	6,5	—	—	—	V60A4D7A—...
31	110	57,5	21	4,5	24	20	70	22,5	26	40	28	—	46	G1/4	43	20	25	3,2	—	—	6,5	—	—	—	V61B4D7A—...
32	89,5	45	16	4,5	18	16	56	17	26	35	28	—	35	G1/8	36	17	22	3,2	—	—	6,5	—	—	—	V60A3D7A—...
32	110	57,5	21	4,5	24	20	70	22,5	26	40	28	—	46	G1/4	43	20	25	3,2	—	—	6,5	—	—	—	V61B3D7A—...
33	132	70	24,5	4,5	26	—	83,5	28	36	55	—	33,5	54	G3/8	52	28	34	4,5	—	—	8,0	—	30	—	V62C4D7A—...
34	132	70	24,5	4,5	26	—	83,5	28	36	55	—	33,5	54	G3/8	52	28	34	4,5	—	—	8,0	—	28	—	V62C3D7A—...
35	162	87,5	38	7,0	46	75	108	33,5	26	65	—	39,5	—	G1/2	64	—	35	—	18,5	5,5	—	23	36	—	V63D4D7A—...
36	162	87,5	38	7,0	46	75	108	33,5	26	65	—	39,5	—	G1/2	64	—	35	—	14,5	5,5	—	23	26	—	V63D3D7A—...

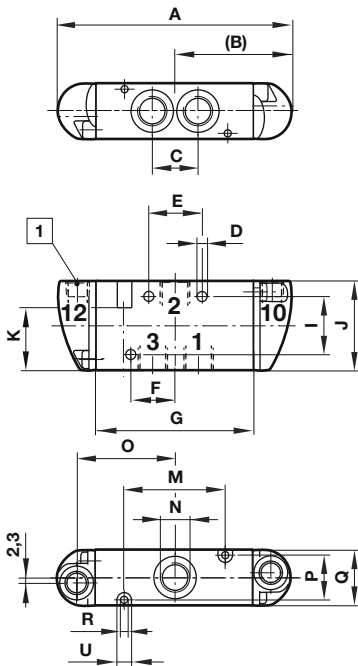
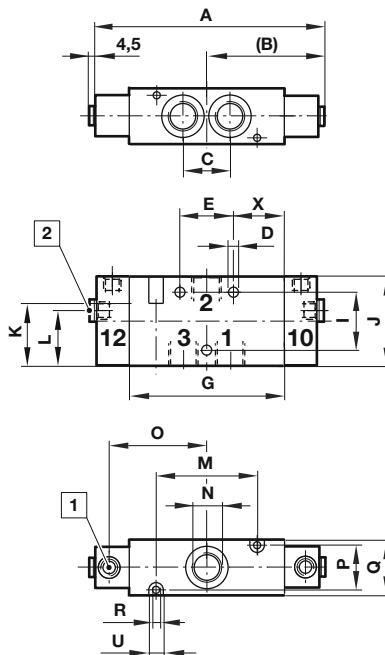
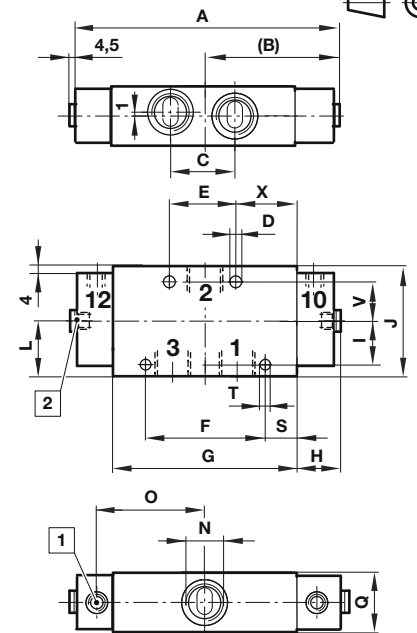
37

38

39

 Dimensions in mm
Projection/First angle

1 Pilot ports G1/8 or 1/8-27 NPT

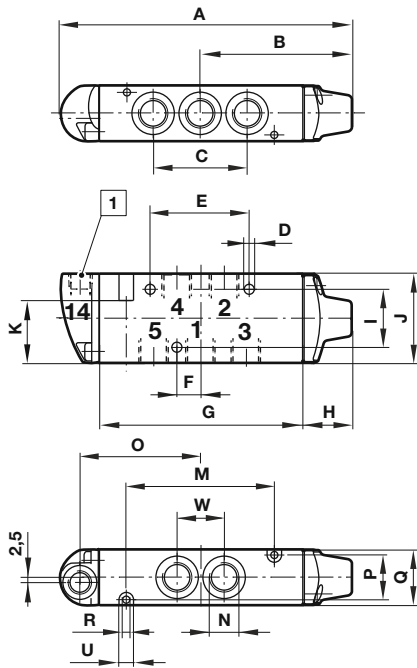
2 Alternative pilot ports G1/8 or 1/8-27 NPT

No.	A	B	C	D	E	F	G	I	J	K	L	M	N	O	P	Q	R	S	T	U	V	X	Model
37	89	44,5	16	4,5	18	16	56	26	35	28	—	35	G1/8	36	17	22	3,2	—	—	6,5	—	—	V60A4DDA—...
37	104	52	21	4,5	24	20	70	26	40	28	—	46	G1/4	43	20	25	3,2	—	—	6,5	—	—	V61B4DDA—...
38	124	62	24,5	4,5	26	—	83,5	36	55	44	33,5	54	G3/8	52	28	34	4,5	—	—	8,0	—	30	V62C4DDA—...
39	148	74	38	7,0	46	75	108	26	65	—	39,5	—	G1/2	64	—	35	—	18,5	5,5	—	23	36	V63D4DDA—...

40



41

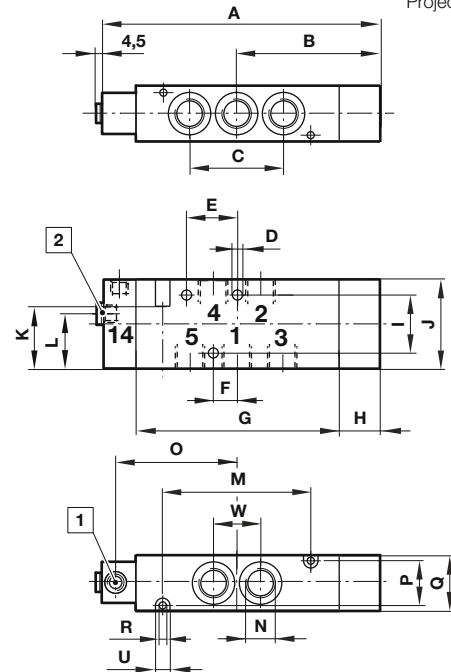

42

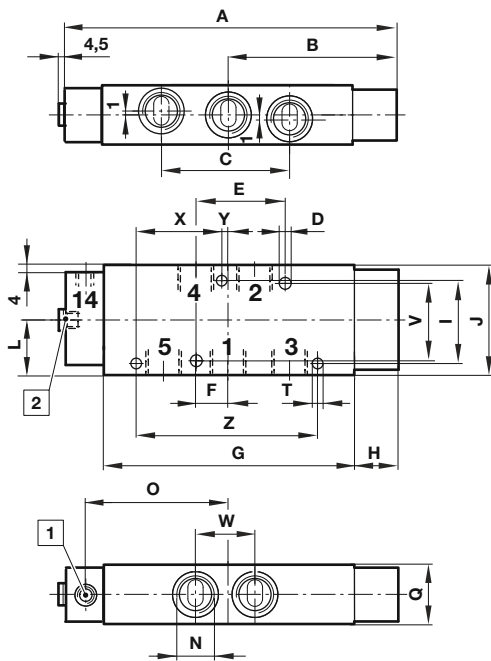

- 1 Pilot ports G1/8 or 1/8-27 NPT
- 2 Alternative pilot ports G1/8 or 1/8-27 NPT

No.	A	B	C	D	E	F	G	H	I	J	K	L	M	N	O	P	Q	R	T	U	V	W	X	Y	Z	Model	
40	105	52,5	32,5	4,5	33,5	8	71	17	26	35	28	—	50	G1/8	43,5	17	22	3,2	—	6,5	—	16	—	—	—	—	V60A5D7A—...
40	130	67,5	42	4,5	44	10	90	22,5	26	40	28	—	66	G1/4	53	20	25	3,2	—	6,5	—	21	—	—	—	—	V61B5D7A—...
41	156	82	49	4,5	26	12	108	28	36	55	44	33,5	78	G3/8	64	28	34	4,5	—	8,0	—	24,5	—	—	—	—	V62C5D7A—...
42	200	106,5	76	7,0	60	19	146	33,5	52	65	—	39,5	—	G1/2	83	—	35	—	5,5	—	46	38	57,5	3	115	V63D5D7A—...	

43

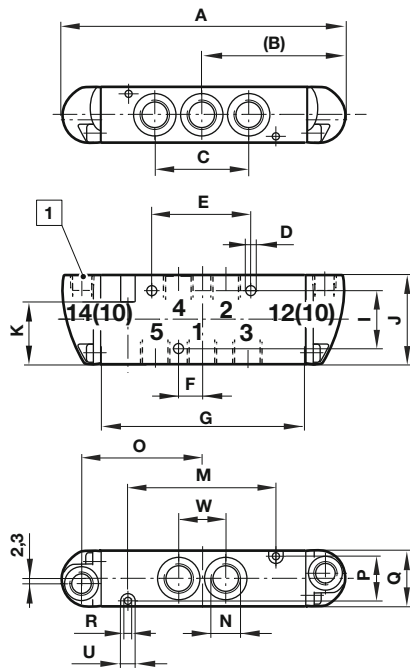

44

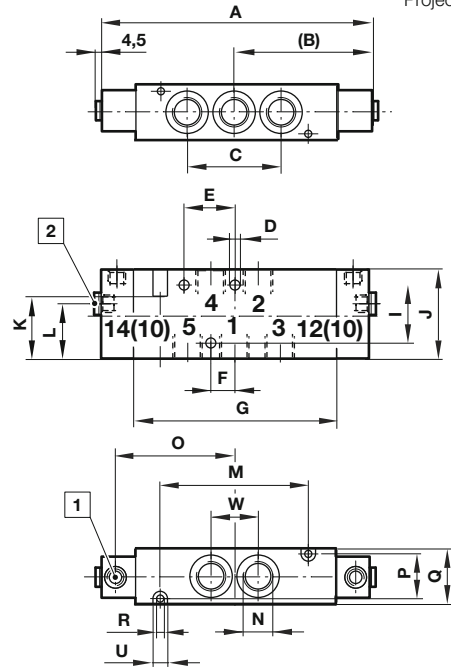

45

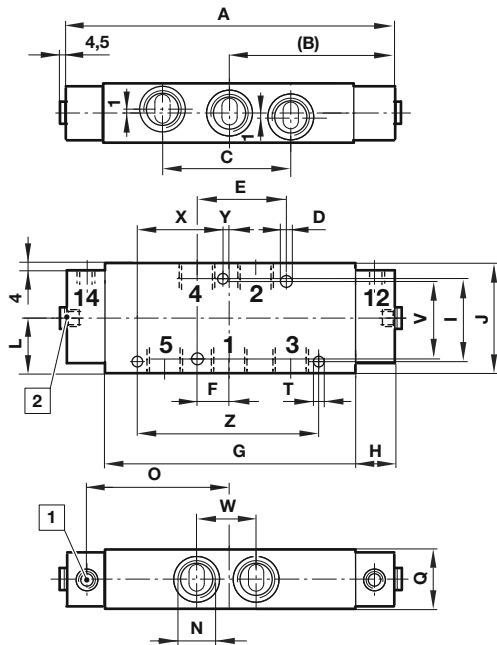

- 1 Pilot ports G1/8 or 1/8-27 NPT
- 2 Alternative pilot ports G1/8 or 1/8-27 NPT

No.	A	B	C	D	E	F	G	H	I	J	K	L	M	N	O	P	Q	R	T	U	V	W	X	Z	Model
43	104,5	52,5	32,5	4,5	33,5	8	71	—	26	35	28	—	50	G1/8	44	17	22	3,2	—	6,5	—	16	—	—	V60A5DDA—...
43	104,5	52,5	32,5	4,5	33,5	8	71	—	26	35	28	—	50	G1/8	44	17	22	3,2	—	6,5	—	16	—	—	V60AADDA—...
43	104,5	52,5	32,5	4,5	33,5	8	71	—	26	35	28	—	50	G1/8	44	17	22	3,2	—	6,5	—	16	—	—	V60ABDDA—...
43	104,5	52,5	32,5	4,5	33,5	8	71	—	26	35	28	—	50	G1/8	44	17	22	3,2	—	6,5	—	16	—	—	V60ACDDA—...
43	124	62	42	4,5	44	10	90	—	26	40	28	—	66	G1/4	53	20	25	3,2	—	6,5	—	21	—	—	V61B5DDA—...
43	124	62	42	4,5	44	10	90	—	26	40	28	—	66	G1/4	53	20	25	3,2	—	6,5	—	21	—	—	V61BADDA—...
43	124	62	42	4,5	44	10	90	—	26	40	28	—	66	G1/4	53	20	25	3,2	—	6,5	—	21	—	—	V61BBDDA—...
43	124	62	42	4,5	44	10	90	—	26	40	28	—	66	G1/4	53	20	25	3,2	—	6,5	—	21	—	—	V61BCDDA—...
44	148	74	49	4,5	26	12	108	—	36	55	44	33,5	78	G3/8	64	28	34	4,5	—	8,0	—	24,5	—	—	V62C5DDA—...
44	148	74	49	4,5	26	12	108	—	36	55	44	33,5	78	G3/8	64	28	34	4,5	—	8,0	—	24,5	—	—	V62CADDA—...
44	148	74	49	4,5	26	12	108	—	36	55	44	33,5	78	G3/8	64	28	34	4,5	—	8,0	—	24,5	—	—	V62CBDDA—...
44	148	74	49	4,5	26	12	108	—	36	55	44	33,5	78	G3/8	64	28	34	4,5	—	8,0	—	24,5	—	—	V62CCDDA—...
45	186	93	76	7,0	60	19	146	—	52	65	—	39,5	—	G1/2	83	—	35	—	5,5	—	46	38	57,5	115	V63D5DDA—...

46

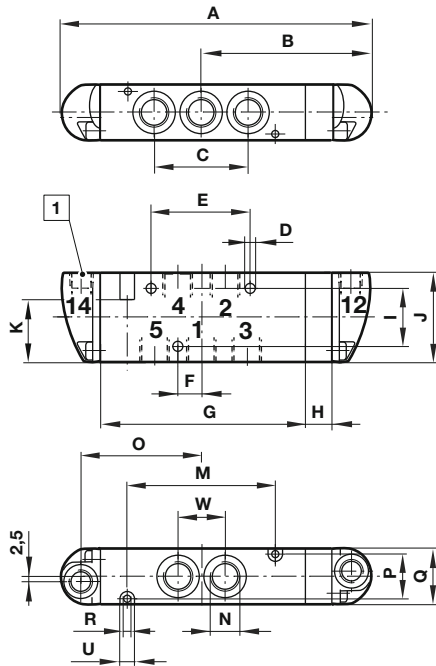

47

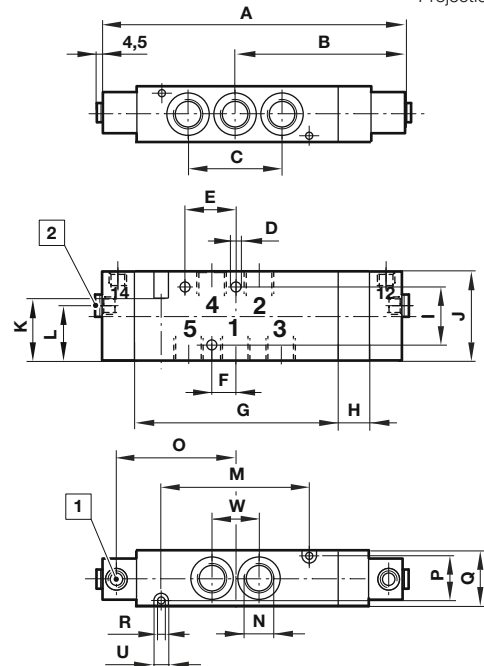

48

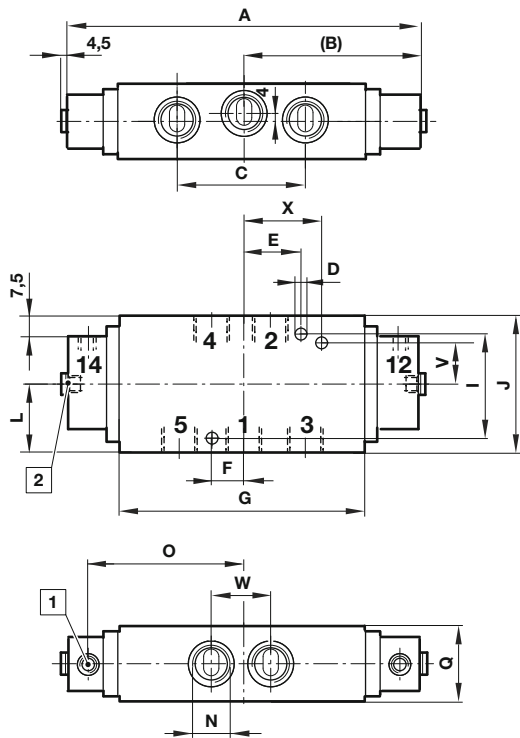

- 1 Pilot ports G1/8 or 1/8-27 NPT
- 2 Alternative pilot ports G1/8 or 1/8-27 NPT

No.	A	B	C	D	E	F	G	H	I	J	K	L	M	N	O	P	Q	R	U	V	W	X	Model
46	118,5	66	32,5	4,5	33,5	8	71	14	26	35	28	—	50	G1/8	43,5	17	22	3,2	6,5	—	16	—	V60A6DDA—...
46	118,5	66	32,5	4,5	33,5	8	71	14	26	35	28	—	50	G1/8	43,5	17	22	3,2	6,5	—	16	—	V60A7DDA—...
46	118,5	66	32,5	4,5	33,5	8	71	14	26	35	28	—	50	G1/8	43,5	17	22	3,2	6,5	—	16	—	V60A8DDA—...
46	142	80	42	4,5	44	10	90	18	26	40	28	—	66	G1/4	53	20	25	3,2	6,5	—	21	—	V61B6DDA—...
46	142	80	42	4,5	44	10	90	18	26	40	28	—	66	G1/4	53	20	25	3,2	6,5	—	21	—	V61B7DDA—...
46	142	80	42	4,5	44	10	90	18	26	40	28	—	66	G1/4	53	20	25	3,2	6,5	—	21	—	V61B8DDA—...
47	170,5	96,5	49	4,5	26	12	108	22,5	36	55	44	33,5	78	G3/8	64	28	34	4,5	8,0	—	24,5	—	V62C6DDA—...
47	170,5	96,5	49	4,5	26	12	108	22,5	36	55	44	33,5	78	G3/8	64	28	34	4,5	8,0	—	24,5	—	V62C7DDA—...
47	170,5	96,5	49	4,5	26	12	108	22,5	36	55	44	33,5	78	G3/8	64	28	34	4,5	8,0	—	24,5	—	V62C8DDA—...
48	216	108	66	7,0	34	16	160	—	50	70	—	41	—	G1/2	98	—	40	—	—	21	33	44	V63D6DDA—...
48	216	108	66	7,0	34	16	160	—	50	70	—	41	—	G1/2	98	—	40	—	—	21	33	44	V63D7DDA—...

Sub bases 2 and 3 stations

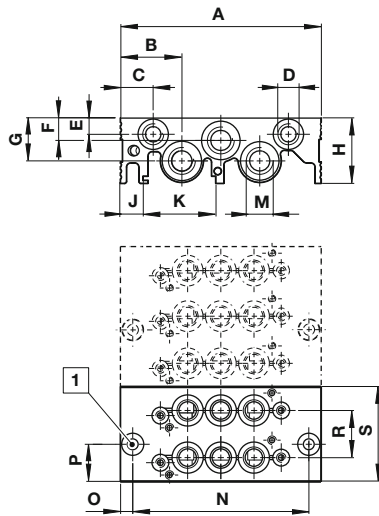

Sub bases 4 to 12 stations

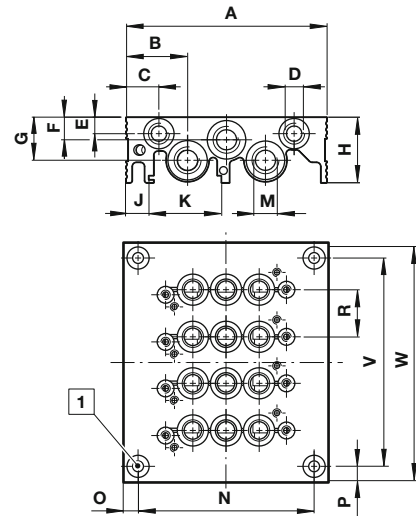

Dimensions in mm
Projection/First angle



1 For M5 bolts only

Series	Valve-stations	A	B	C	D	E	F	G	H	J	K	M	N	O	P	R	S	V *2)	W *2)	Weight (kg) *2)	Model
V60	2	98	30	16	G1/8	8	11	21	32	11	35,5	G1/4	86	6	28	23	46	—	46	0,23	2221002
V60	3	98	30	16	G1/8	8	11	21	32	11	35,5	G1/4	86	6	28	23	69	—	69	0,28	2221003
V60	4 » 12	98	30	16	G1/8	8	11	21	32	11	35,5	G1/4	86	6	6,5	23	—	(N x 23) +10	(N x 23) +23	4 stations = 0,61 *2)	22210*1)
V61	2	104	26	9	G1/8	8	13	20	33	10	35,5	G3/8	24	40	26	26	52	—	52	0,28	2221102
V61	3	104	26	9	G1/8	8	13	20	33	10	35,5	G3/8	24	40	52	26	78	—	78	0,45	2221103
V61	4 » 12	104	26	9	G1/8	8	13	20	33	10	35,5	G3/8	24	40	6,5	26	—	(N x 26) +10	(N x 26) +23	4 stations = 0,72 *2)	22211*1)
V62	2	120	29	9	G1/8	8	15	22	38	12	35,5	G1/2	32	44	35	35	70	—	70	0,50	2221202
V62	3	120	29	9	G1/8	8	15	22	38	12	35,5	G1/2	32	44	70	35	105	—	105	0,85	2221203
V62	4 » 12	120	29	9	G1/8	8	15	22	38	12	35,5	G1/2	32	44	7	35	—	(N x 35) +12	(N x 35) +26	4 stations = 1,25 *2)	22212*1)

*1) Insert sub—base code after model numbers: 04, 06, 08, 10 and 12 corresponding the stations
*2) Add +0,25 for two further stations V60 series, +0,30 for V61 and +0,54 for V62 series

Mounting instructions

Pressure shut-off part

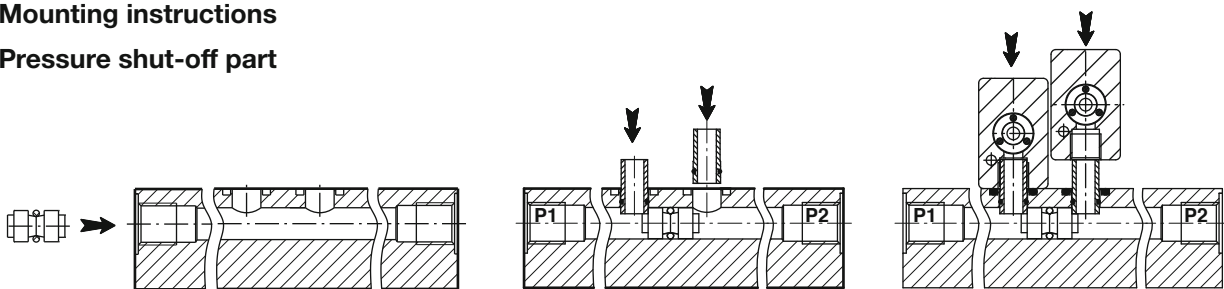

1. Set stopper at required position (in main pressure line).

2. Insert two bushes to lock stopper in position.

3. Mount valves on sub-base (bushes rise into P port of valves).

Extension possibilities of sub-bases

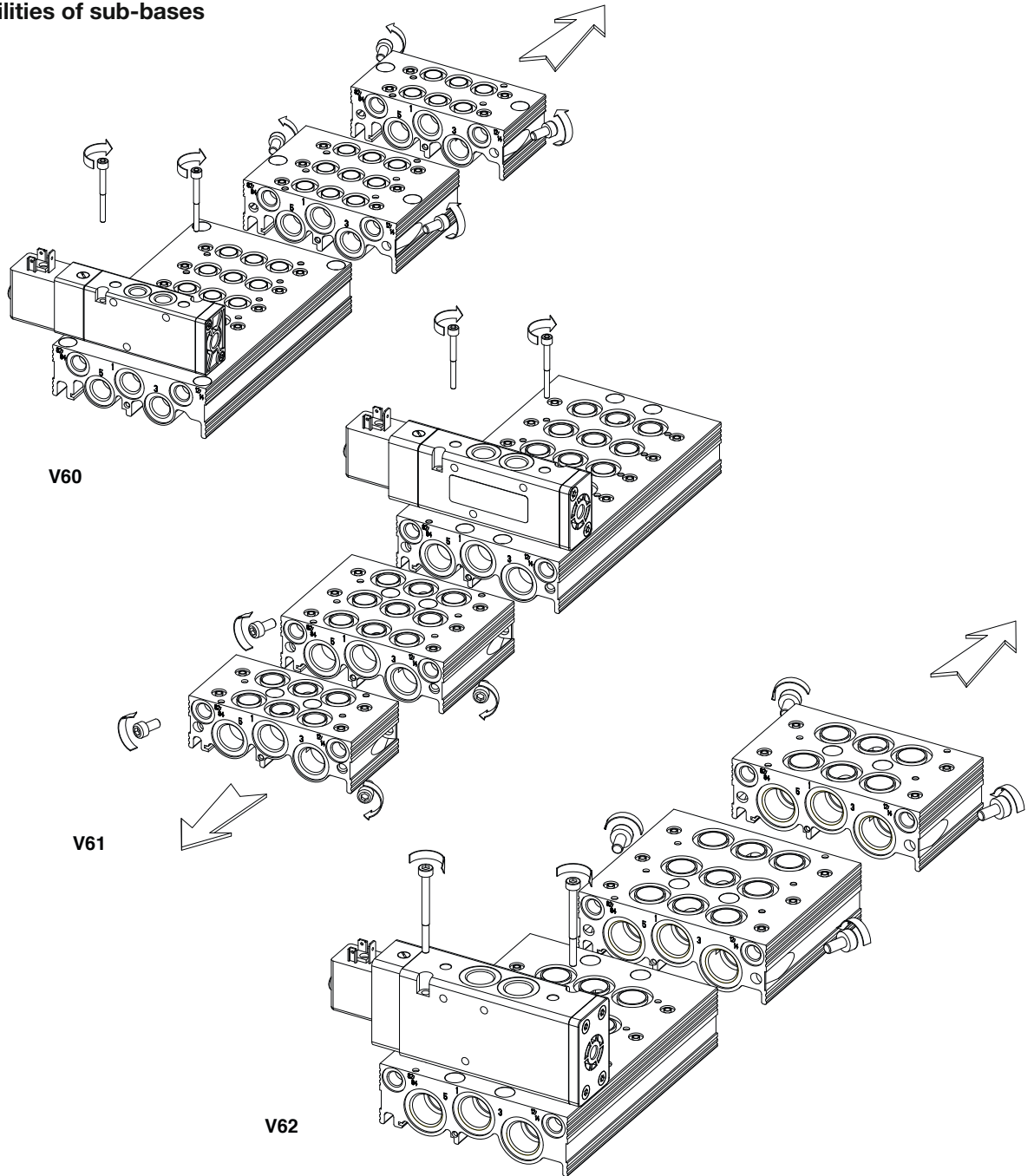

Screw torque for sub-base

M3 = 0,7 +0,3 Nm

M4 = 1,6 +0,5 Nm

M5 = 3,4 +0,5 Nm

M6 = 5,2 +0,5 Nm

Mounting kit for DIN rail

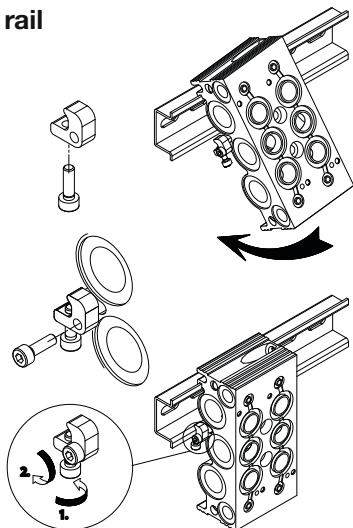

Manifold for common pressure supply

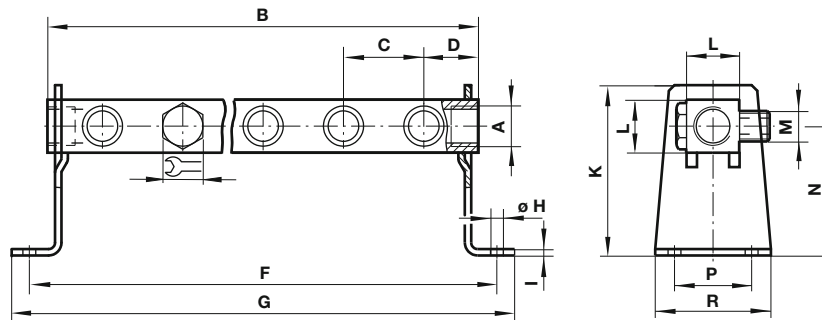
 Dimensions in mm
Projection/First angle

Series	Valve stations	A	B	C	D	E	F	G	Ø H	I	K	L	M	N	P	R	Weight (kg)	Model
V60	2	G1/4	76	32	22	14	90	106	6,5	2,5	60	16	G1/8	48	28	42	0,053	2639622
V60	3	G1/4	108	32	22	14	122	138	6,5	2,5	60	16	G1/8	48	28	42	0,075	2639623
V60	4	G1/4	140	32	22	14	154	170	6,5	2,5	60	16	G1/8	48	28	42	0,099	2639624
V60	5	G1/4	172	32	22	14	186	202	6,5	2,5	60	16	G1/8	48	28	42	0,123	2639625
V60	6	G1/4	204	32	22	14	218	234	6,5	2,5	60	16	G1/8	48	28	42	0,147	2639626
V60	7	G1/4	236	32	22	14	250	266	6,5	2,5	60	16	G1/8	48	28	42	0,174	2639627
V60	8	G1/4	268	32	22	14	282	298	6,5	2,5	60	16	G1/8	48	28	42	0,194	2639628
V60	9	G1/4	300	32	22	14	314	330	6,5	2,5	60	16	G1/8	48	28	42	0,209	2639629
V60	10	G1/4	332	32	22	14	346	362	6,5	2,5	60	16	G1/8	48	28	42	0,230	2639630
V60	12	G1/4	396	32	22	14	410	426	6,5	2,5	60	16	G1/8	48	28	42	0,280	2639632
V61	2	G3/8	85	35	25	19	100	116	6,5	3	75	23	G1/4	57	35	50	0,130	2639422
V61	3	G3/8	120	35	25	19	135	151	6,5	3	75	23	G1/4	57	35	50	0,192	2639423
V61	4	G3/8	155	35	25	19	170	186	6,5	3	75	23	G1/4	57	35	50	0,250	2639424
V61	5	G3/8	190	35	25	19	205	221	6,5	3	75	23	G1/4	57	35	50	0,309	2639425
V61	6	G3/8	225	35	25	19	240	256	6,5	3	75	23	G1/4	57	35	50	0,367	2639426
V61	7	G3/8	260	35	25	19	275	291	6,5	3	75	23	G1/4	57	35	50	0,421	2639427
V61	8	G3/8	295	35	25	19	310	326	6,5	3	75	23	G1/4	57	35	50	0,482	2639428
V61	9	G3/8	330	35	25	19	345	361	6,5	3	75	23	G1/4	57	35	50	0,537	2639429
V61	10	G3/8	365	35	25	19	380	396	6,5	3	75	23	G1/4	57	35	50	0,595	2639430
V61	12	G3/8	435	35	25	19	450	466	6,5	3	75	23	G1/4	57	35	50	0,642	2639432

Warning

These products are intended for use in industrial compressed air systems only. Do not use these products where pressures and temperatures can exceed those listed under »**Technical features/data**«.

Before using these products with fluids other than those specified, for non-industrial applications, life-support systems or other applications not within published specifications, consult IMI Precision Engineering, Norgren GmbH.

Through misuse, age, or malfunction, components used in fluid power systems can fail in various modes. The system designer is warned to consider the failure modes of all component parts used in fluid power systems and to provide adequate safeguards to prevent personal injury or damage to equipment in the event of such failure.

System designers must provide a warning to end users in the system instructional manual if protection against a failure mode cannot be adequately provided.

System designers and end users are cautioned to review specific warnings found in instruction sheets packed and shipped with these products.